



LED Tri-proof Light SPEC



J01

LED TRI-PROOF LIGHT

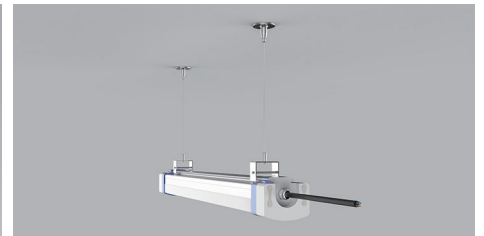
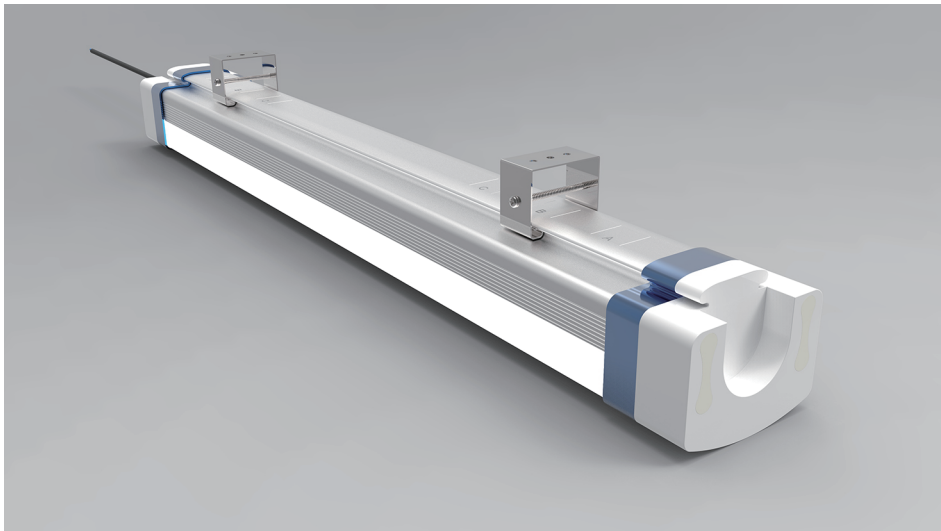
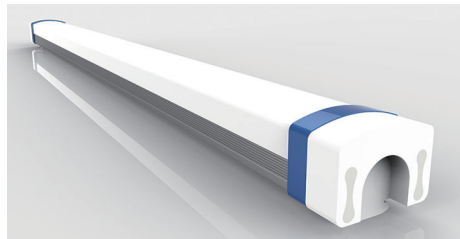

PLS Note : The Luminaires are intended for indoor use or under shelter for outdoor use.



■ Matters needing attention

- ◆ Before installing the lighting fixtures, please read this instruction manual carefully.
- ◆ The lighting fixtures should be installed, connected and tested by a certified installer based on the local regulations.
- ◆ Lamps should always be installed or replaced with care.
- ◆ Please check the local voltage in accordance with the product requirements before using the product.
- ◆ Relamping only can be done when the power is off and the lamp is completely cooled down.
- ◆ When a lamp is to be cleaned, make the power off and let it cool down completely. Clean the fixture with a soft cloth and a standard PH neutral detergent. Stainless steel finishing should be maintained regularly.
- ◆ Misuse of, or changes to the fixture shall nullify the guarantee.
- ◆ Don't cover the fixtures with flammable materials.
- ◆ Exclusively replaced by the manufacturer or his service agent or the similar qualified person in order to avoid a hazard.

■ Product Number Explanation

PS: ABCDEFG-HIJK-LM
 1 2 3 4 5 6 7

- 1 Type Line
- 2 Series
- 3 Size
- 4 Power
- 5 Function
- 6 CCT
- 7 Version

CCT Range: WW(3000K), NW(4000K), DW(5000K), CW(6500K)

■ Temperature Characteristics T-ambient 25°C

Temperature
 Operating -20~+40 °C
 Storage -40~+85 °C

■ Electrical Characteristics

Input Voltage: AC100~277V 50/60Hz
 PF: ≥0.95 THD < 20%
 Power Efficiency: ≥0.92



1. Features

- ◆ Tri-proof led fixture for IP66 water-proof, dust-proof and corrosion-proof
- ◆ Patent and functional design with imaginative appearance
- ◆ Excellent heat dissipation depending on whole aluminum housing
- ◆ Widely use for ambient lighting application
- ◆ Maximum efficacy and minimum glare
- ◆ High-tech optical design
- ◆ No UV ,No lead, No mercury
- ◆ Suitable for wet locations
- ◆ 3 years warranty
- ◆ cULus DLC ROHS certification

2. Application

COMMERCIAL LIGHTING	PUBLIC LIGHTING	INDUSTRIAL LIGHTING
Supermarket Exhibition hall Parking place Etc	Tunnel MTR station Train station Bus station Airport Etc	Factory/Warehouse Etc

3. Product Dimension

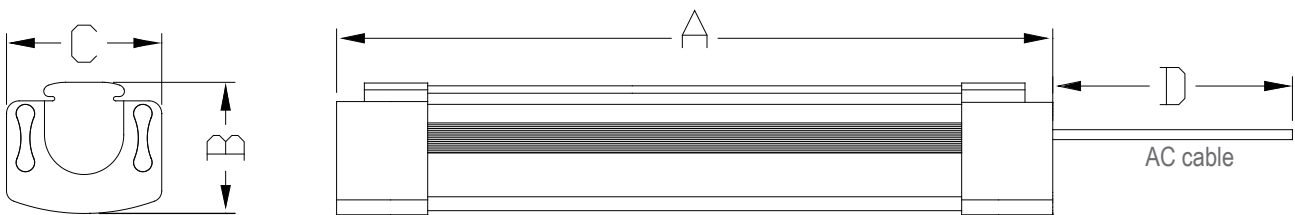

Model NO.	Size A(mm)	Size B(mm)	Size C(mm)	Size D(mm)
J010600-20CO-XA	600	71	84	800
J010900-30CO-XA	900	71	84	800
J011200-40CO-XA	1200	71	84	800
J011500-50CO-XA	1500	71	84	800
J011500-65CO-XA	1500	71	84	800



4. Parameter

Model NO.	Power (W)	Light Source	LED QTY (pcs)	CCT (K)	Frosted Lumens	Cover Lm/W	Clear Cover Lumens	Clear Cover Lm/W	CRI	Beam Angle
J010600-20CO-XA	20	2835	108	4000K	2400	120	2600	130	>80	120°
J010900-30CO-XA	30	2835	156	4000K	3600	120	3900	130	>80	120°
J011200-40CO-XA	40	2835	216	4000K	4800	120	5200	130	>80	120°
J011500-50CO-XA	50	2835	264	4000K	6000	120	6500	130	>80	120°
J011500-65CO-XA	65	2835	324	4000K	7800	120	8450	130	>80	120°

CCT Range: WW(3000K), NW(4000K), DW(5000K), CW(6500K)

5. Installation

A. Suspending

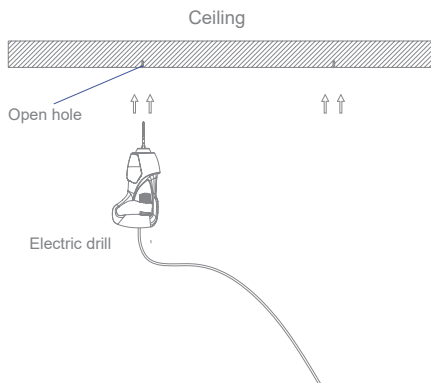

A : Make a right position and screw hole

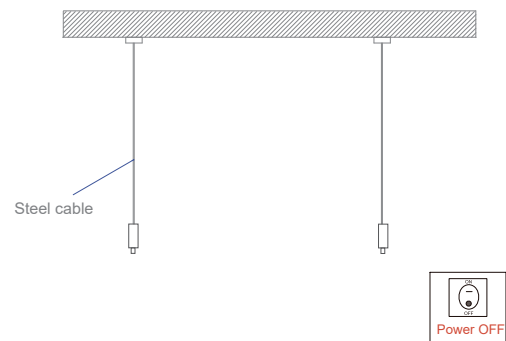

B : Screw the steel cable onto the ceiling

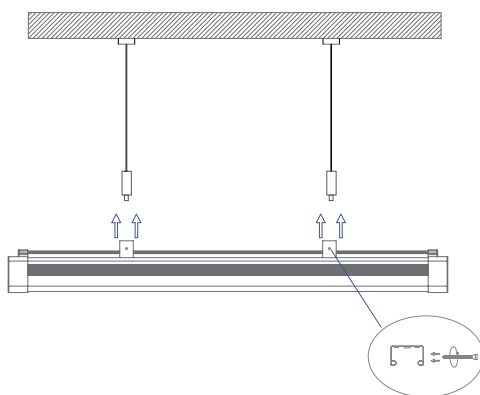

C : Hung the fixture under the steel cable and secure the fixture by steel cable

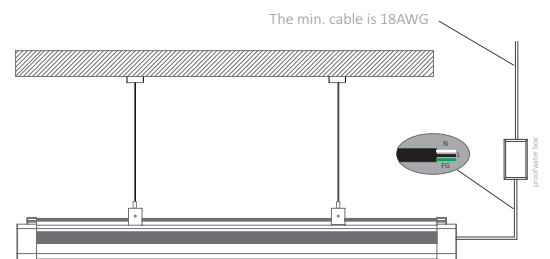

PLS note : PLS put the terminal of power cable into water proof box and use a listed water proof bushing when you link the power

D: Adjust the position of the fixture and clean it..



B. Ceiling Mounted

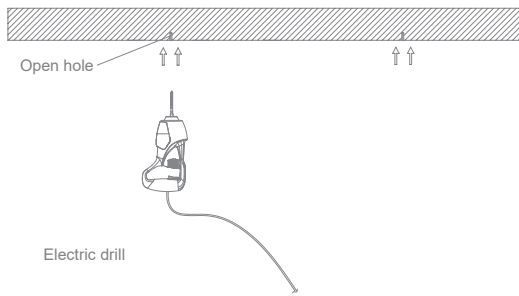

A: Make a right position and screw hole

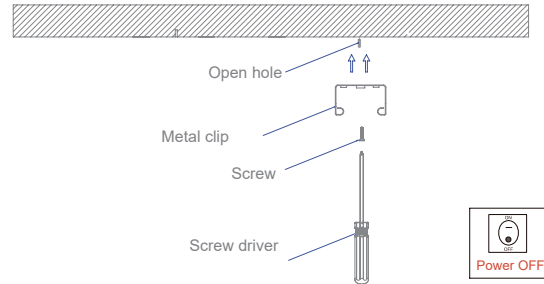

B: Screw the clip on the ceiling tightly

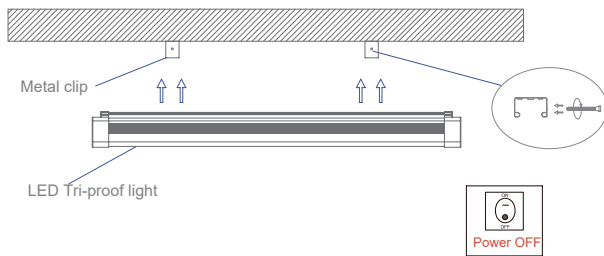

C: Install the lamp into the clips.

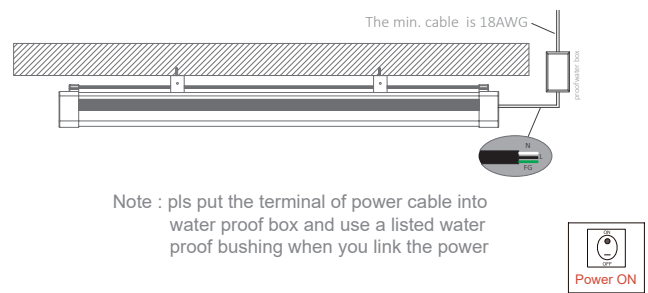

D: Adjust the position of the fixture and clean it..

◆ Pls note : Above installation“ B” belongs to our standard installation, if you want to choose our way of “A” installation then you need to select our optional accessories and pay.

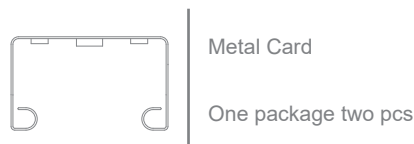

Standard accessories

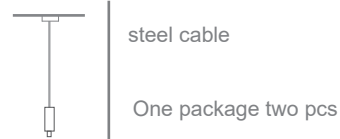

Optional accessories

6. Wiring Diagram

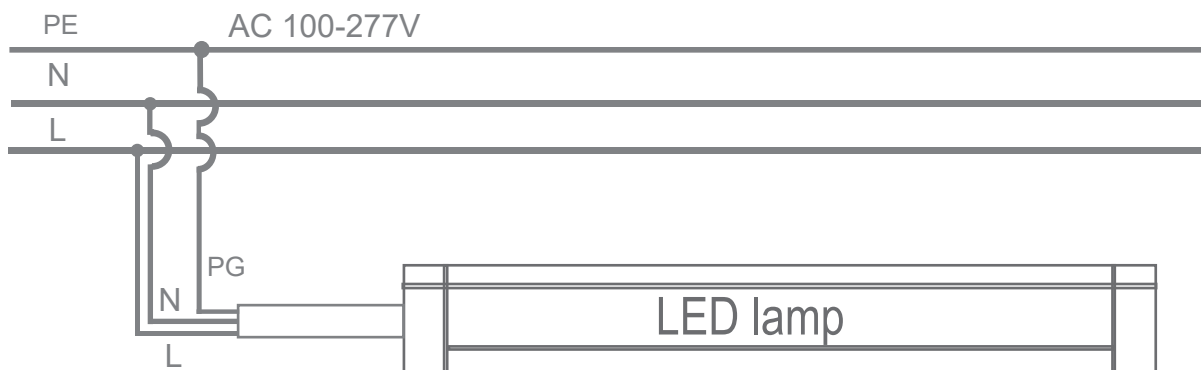



7. Packaging

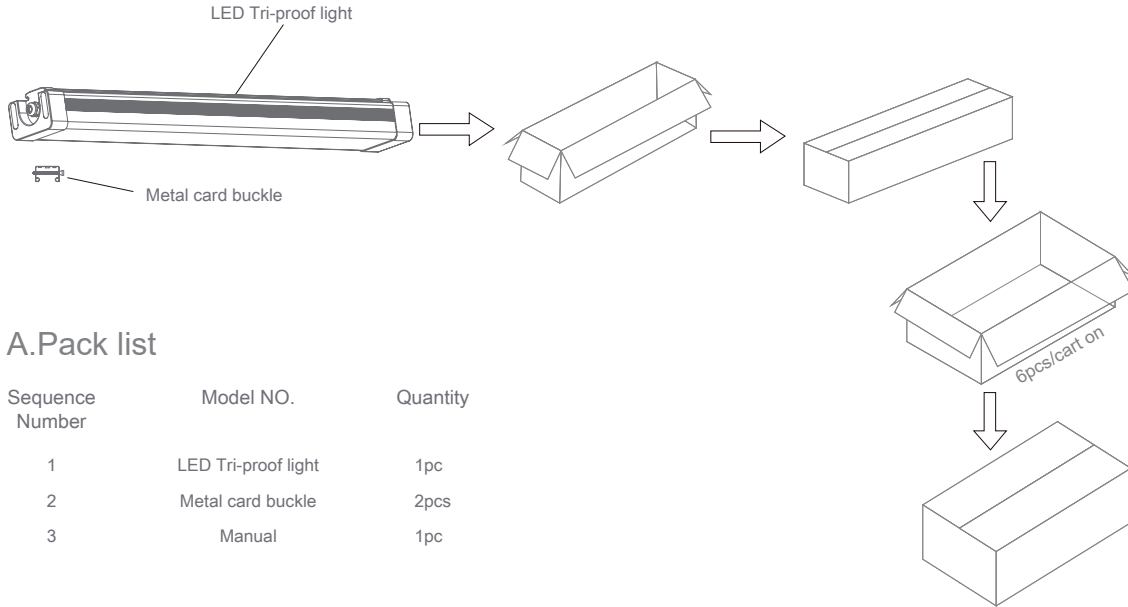

A.Pack list

Sequence Number	Model NO.	Quantity
1	LED Tri-proof light	1pc
2	Metal card buckle	2pcs
3	Manual	1pc

B.Packing Data

Model No.	Single Box	Pcs/CTN	N .W. / pcs (kg)	G .W. /CTN (kg)	Meas (mm)
J010600-20CO-XA	1	6	1.877	12.362	685x307x223
J010900-30CO-XA	1	6	2.579	17.074	985x307x223
J011200-40CO-XA	1	6	3.342	22.152	1285x307x223
J011500-50CO-XA	1	6	3.981	26.685	1585x307x223
J011500-65CO-XA	1	6	4.096	27.086	1585x307x223

8. Safety & EMC

- Safety standards UL 8750; UL 1598; EN 60598-1: 2015; EN 60598-2-2: 2012; EN 62031: 2008+A1: 2013+A2: 2015; EN 62493: 2015; EN 62471: 2008;
- EMC emission Compliance to EN55015: 2013, EN61000-3-2: 2014; EN61000-3-3: 2013;
- EMC immunity Compliance to EN61547: 2009;

9. Lamp Block Diagram

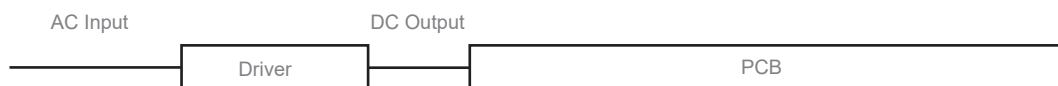



Joytech Products Co., Ltd.

J01 Tri-proof Light



10. Attention

This specification is for reference only, we reserve the right to change without notice.