



Joytech Products Co., Ltd.

UL Type A LED Tube (DLC4.0 Standard)



Product Description

- ◆ UL Listed Classified, Dual Mode internal Driver (UL type A);
- ◆ Compatible with electronic instant start ballasts;
- ◆ Direct replacement for traditional tubes, no need to remove the ballast & rewire;
- ◆ Voltage: AC 100-277V;
- ◆ High power factor ≥ 0.90 , THD $< 25\%$;
- ◆ Light source: SMD2835;
- ◆ High efficiency, up to 140 Lm/W;
- ◆ High CRI > 80 ;
- ◆ Warranty: 5 years.

Dimension

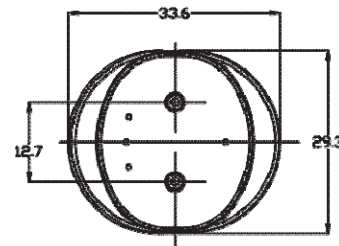
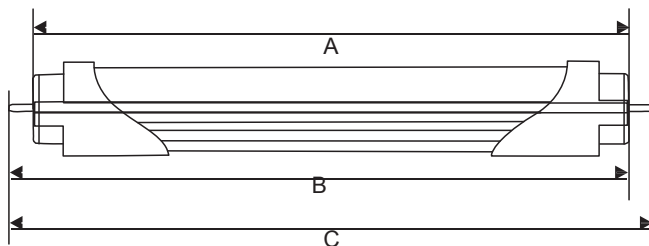

Size(FT)	2			Explain
	Typical	Min	Max	
Length(mm)				
A	588	—	589.8	Base face to base face
B	595.5	594.4	596.9	Base face to end opposite base pin
C	603	601.2	604	End of base pin to end of opposite pin end

Parameters

JP-BDT82FUA-8WB-SWMF

Size	0.6M/2Ft				
Power consumption	8W				
Cover	Milky				
Color temperature	3000K	3500K	4000K	4500K	5000K
Luminous efficiency (Lm/W)	115 ±5%	115 ±5%	120 ±5%	120 ±5%	120 ±5%
Luminous flux (Lm)	920 ±5%	920 ±5%	960 ±5%	960 ±5%	960 ±5%
CRI	Ra≥80				
Input Voltage	AC 100-277V				
Frequency range	47-63Hz				
Total Harmonic Distortion	<25%				
Beam Angle	120°				
Working Temperature	-20°C ~ 45°C				
Storage Temperature	-25°C ~ 65°C				

Optical Data & Diagram

JPBDT82FUA-8WB-SWMF

LUMINOUS INTENSITY DISTRIBUTION DIAGRAM

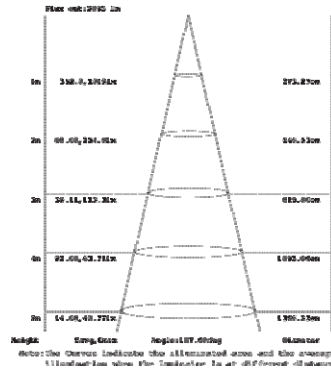
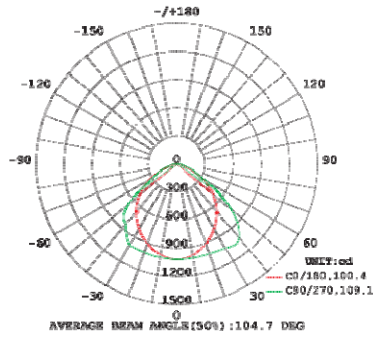

JPBDT84FUA-12WB-SWMF

LUMINOUS INTENSITY DISTRIBUTION DIAGRAM

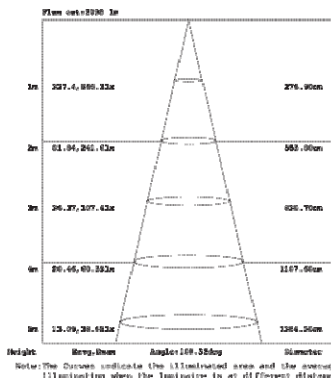
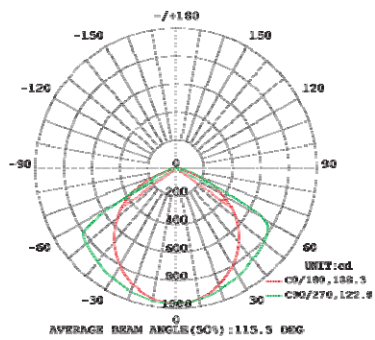

JPBDT84FUA-16WB-SWMF

LUMINOUS INTENSITY DISTRIBUTION DIAGRAM

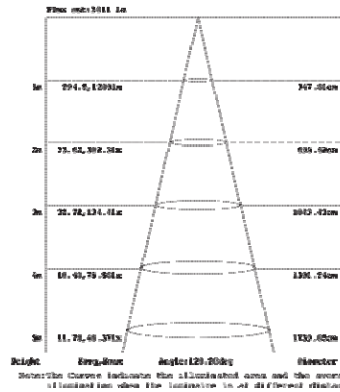
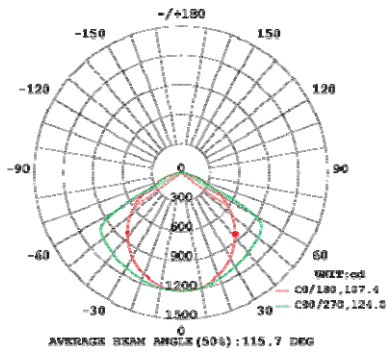

JPBDT84FUA-20WB-SWMF

LUMINOUS INTENSITY DISTRIBUTION DIAGRAM

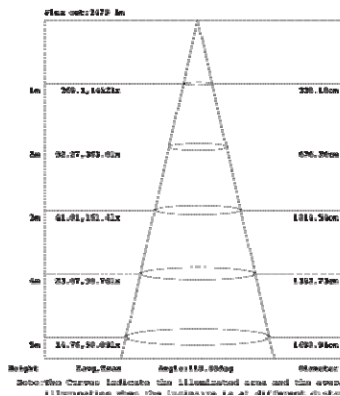
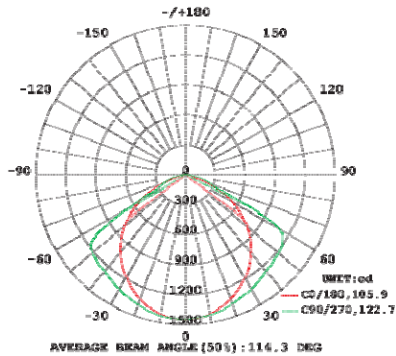

Installation steps

Compatible with Ballast

1. Turn off the electricity supply before installation.
2. Make sure the circuit is as following. Please follow the illustrated steps to revise the circuit as follow

Take with Electronic Ballast

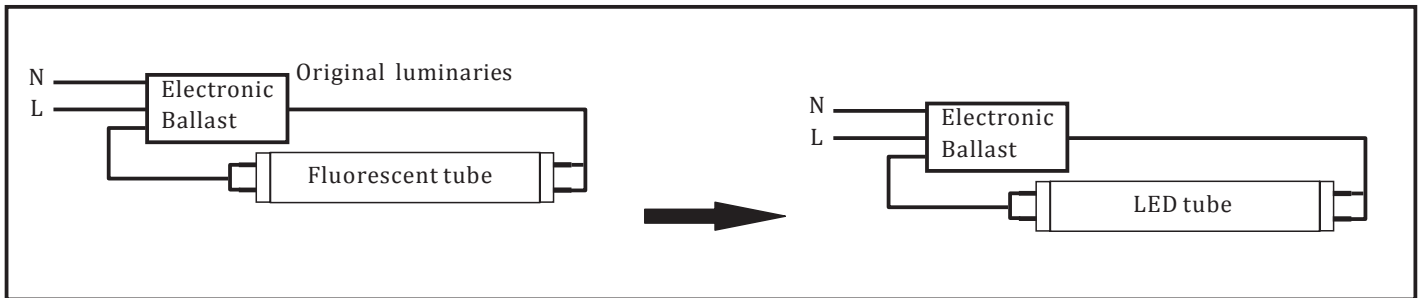

3. Install the LED tubes in standard medium bi-pin lamp holder.
4. "After modification completes, then affix the Lamping Replacement Marking label and cautionary label, located this where visible during re-lamping on the retrofitted luminaries."

Package

Item	Carton Size(cm)	Q'ty	N.W.	G.W.	20GP	40HQ
T8-2FT	63.5x21x21.5cm	25pcs/carton	0.15kg/pc	5.8kg/CTN	27875pcs/1115CTN	57500pcs/2300CTN
T8-4FT	124x21x21.5cm	25pcs/carton	0.30kg/pc	10kg/CTN	14000pcs/560CTN	28900pcs/1156CTN

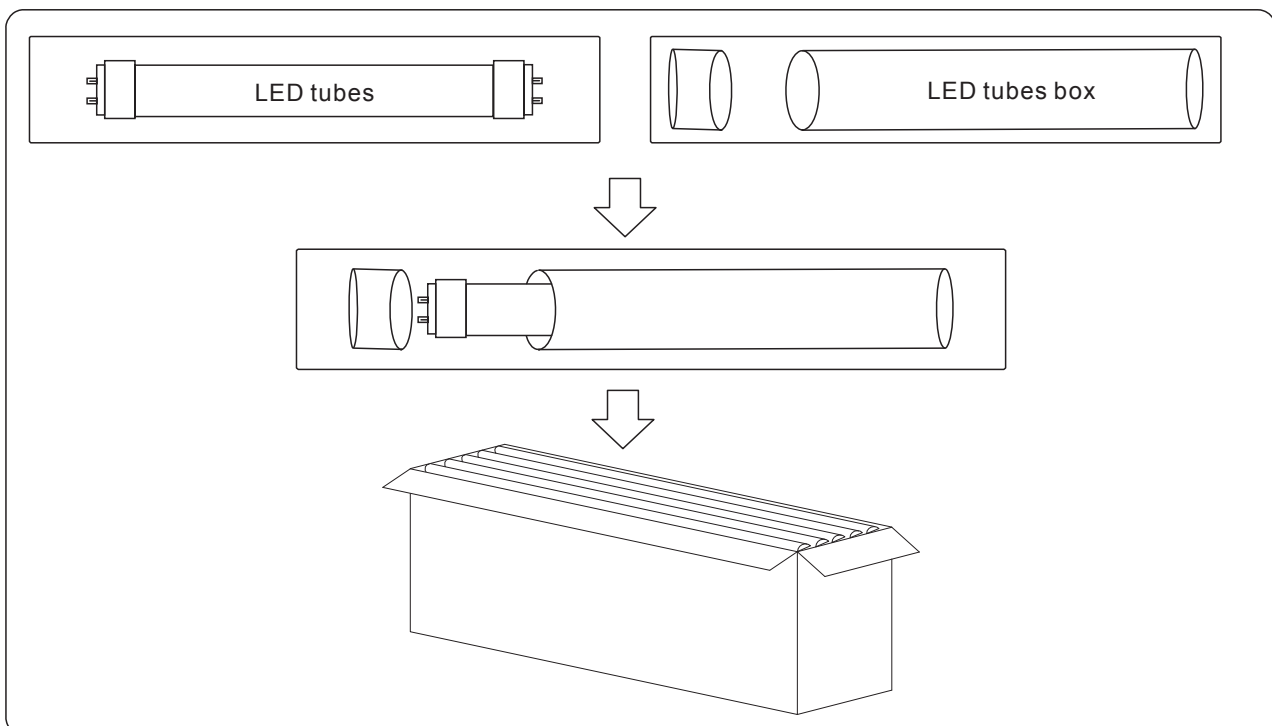

Application

Replacement for conventional panel lights:

Hotels / Meeting Rooms

Factories / Offices / Car parks /Schools

Hospitals / Supermarkets / Railway Stations & Airports



metro



bookshop

Warranty

- We will replace all the failed products due to we production quality during warranty period;
- 5 years warranty;
- We will bear all cost of maintains if the customer can help us to repair locally;
- We don't have the responsibility to compensate for any incorrect installation or artificial damage;
- We don't have the responsibility to compensate for damage occurred during the transit.

Warning

- ◆ Please use the product within the specified range of voltage;
- ◆ Please follow the correct installation steps to install the product, and do not touch when it is working;
- ◆ Please turn power off when installing and removing the products to avoid risk of electric shock;
- ◆ Please install the tube in the correct sized fixture;
- ◆ Do not look directly at LED light source for a long time;

JOYTECH PRODUCTS CO.,LTD

1F, No.15, Lane 27, Sec.3 Chung-king South Rd., Taipei 100, Taiwan, R.O.C

Tel : 886-2-23582899 Fax : 886-2-23415778

E-Mail : sales@joytech-jpc.com.tw Website : www.joytech-jpc.com.tw